



Discontinued
Last time buy: August 31, 2012

Panasonic
ideas for life

**1.8 GHZ
HIGH FREQUENCY,
4 mm LOW PROFILE
RELAY**

RP RELAYS



RoHS compliant

FEATURES

1. High frequency relay with the low profile of 4 mm .157 inch
2. Excellent high frequency characteristics
 - Isolation: Min. 10dB (at 1.8 GHz)
 - Insertion loss: Max. 1.0dB (at 1.8 GHz)
 - V.S.W.R.: Max. 1.3 (at 1.8 GHz)
3. High sensitivity in small size
Size: 10.6 × 9 × 4 mm
.417 × .354 × .157 inch
Nominal operating power: 140 mW
4. Utilizes tube package for automatic mounting.

5. Self-clinching terminal also available

TYPICAL APPLICATIONS

- Switching signal of measuring equipment
- All types of compact wireless devices

If you wish to use in applications with low level loads or with high frequency switching, please consult us.

ORDERING INFORMATION

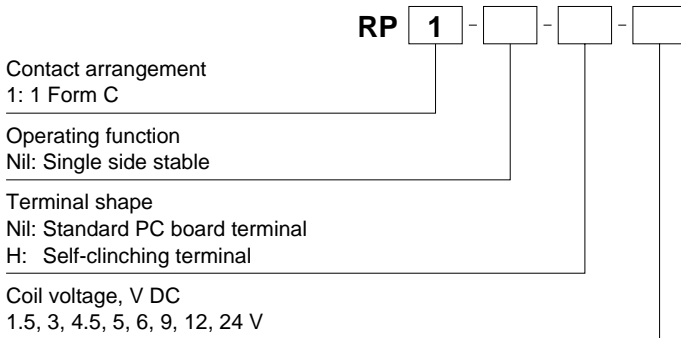

TYPES

Contact arrangement	Nominal coil voltage	Standard PC board terminal	
		Single side stable	Self-clinching terminal Single side stable
		Part No.	Part No.
1 Form C	1.5V DC	RP1-1.5V	RP1-H-1.5V
	3 V DC	RP1-3V	RP1-H-3V
	4.5V DC	RP1-4.5V	RP1-H-4.5V
	5 V DC	RP1-5V	RP1-H-5V
	6 V DC	RP1-6V	RP1-H-6V
	9 V DC	RP1-9V	RP1-H-9V
	12 V DC	RP1-12V	RP1-H-12V
	24 V DC	RP1-24V	RP1-H-24V

Standard packing: 50 pcs. in an inner package (tube); 1,000 pcs. in an outer package

RATING

1. Coil data

Nominal coil voltage	Pick-up voltage (at 20°C 68°F)	Drop-out voltage (at 20°C 68°F)	Nominal operating current [±10%] (at 20°C 68°F)	Coil resistance [±10%] (at 20°C 68°F)	Nominal operating power	Max. applied voltage (at 20°C 68°F)
1.5V DC	75%V or less of nominal voltage* (Initial)	10%V or more of nominal voltage* (Initial)	93.8mA	16 Ω	140mW	150%V of nominal voltage
3 V DC			46.7mA	64.3Ω		
4.5V DC			31.0mA	145 Ω		
5 V DC			28.1mA	178 Ω		
6 V DC			23.3mA	257 Ω		
9 V DC			15.5mA	579 Ω		
12 V DC			11.7mA	1,028 Ω		
24 V DC			11.3mA	2,133 Ω		

*Pulse drive (JIS C5442)



Discontinued
Last time buy: August 31, 2012

RP

2. Specifications

Characteristics	Item	Specifications	
Contact	Arrangement	1 Form C	
	Initial contact resistance, max.	Max. 50mΩ (By voltage drop 6V DC 0.1A)	
	Contact material	Stationary: Ag + Au clad, Movable: AgPd	
Rating	Contact rating	0.1A 30V DC (resistive load); Contact carrying power: 3W (Max. 1.2GHz); 1W (Max. 1.8GHz); Contact switching power: 1W (Max. 1.8GHz)	
	Nominal operating power (single side stable type)	140mW (1.5 to 12V DC), 270mW (24V DC)	
High frequency characteristics (Initial) (Impedance 50Ω)	V.S.W.R.	Max. 1.2 (at 1GHz), Max. 1.3 (at 1.8GHz)	
	Insertion loss (without D.U.T. board's loss)	Max. 0.5dB (at 1GHz), Max. 1dB (at 1.8GHz)	
	Isolation	Min. 15dB (at 1GHz), Min. 10dB (at 1.8GHz)	
Electrical characteristics	Insulation resistance (Initial)	Min. 1,000MΩ (at 500V DC) Measurement at same location as "Initial breakdown voltage" section.	
	Breakdown voltage (Initial)	Between open contacts	750 Vrms for 1min. (Detection current: 10mA)
		Between contact and coil	1,500 Vrms for 1min. (Detection current: 10mA)
	Temperature rise (at 20°C)	Max. 50°C (By resistive method, nominal voltage applied to the coil, contact carrying power: 1W/at 1.8GHz)	
	Operate time (at 20°C)	Max. 3ms (Approx. 1.5ms) (Nominal operating voltage applied to the coil, excluding contact bounce time.)	
Release time (at 20°C)	Max. 2ms (Approx. 1ms) (Nominal operating voltage applied to the coil, excluding contact bounce time.) (without diode)		
Mechanical characteristics	Shock resistance	Functional	Min. 500 m/s ² {Approx. 50G} (Half-wave pulse of sine wave: 11ms; detection time: 10μs.)
		Destructive	Min. 1,000 m/s ² {Approx. 100G} (Half-wave pulse of sine wave: 6ms.)
	Vibration resistance	Functional	10 to 55 Hz at double amplitude of 3mm (Detection time: 10μs.)
		Destructive	10 to 55 Hz at double amplitude of 5mm
Expected life	Mechanical	Min. 5×10 ⁶ (at 180 cpm)	
	Electrical	Min. 10 ⁵ (0.1A 30V DC resistive load, 1W (at 1.8GHz, V.S.W.R. max. 1.3 at 20 cpm)	
Conditions	Conditions for operation, transport and storage*	Ambient temperature: -40°C to +70°C -40°F to +158°F Humidity: 5 to 85% R.H. (Not freezing and condensing at low temperature)	
	Max. operating speed (at rated load)	20 cpm (at rated load)	
Unit weight		Approx. 1 g .04 oz	

Note: * The upper operation ambient temperature limit is the maximum temperature that can satisfy the coil temperature rise value. Refer to [6] AMBIENT ENVIRONMENT in GENERAL APPLICATION GUIDELINES.

REFERENCE DATA

1. High frequency characteristics

Sample: RP1-6V

Measuring method: Impedance 50Ω

Measuring tool:

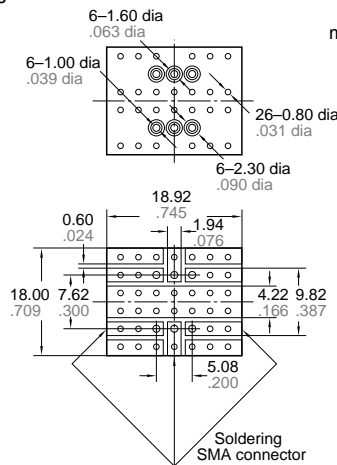

mm inch

PC board

- Double-sided through hole
- Material: Glass-epoxy resin
- t = 1.0mm .039 inch
- Copper plated thickness: 35 μm

• V.S.W.R.

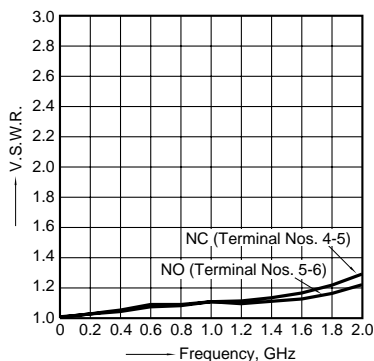

• Insertion loss

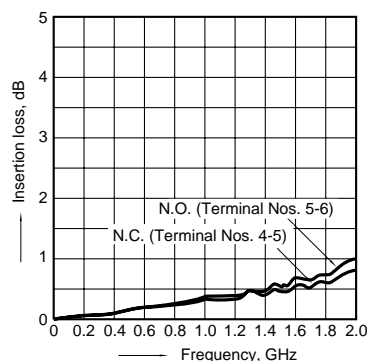

• Isolation

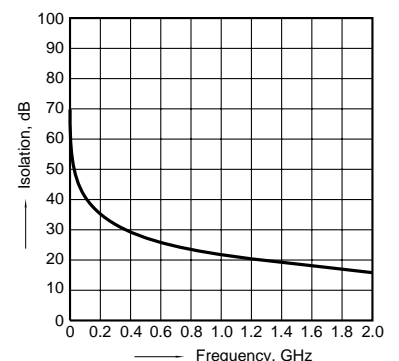



2. Coil temperature rise

Sample: RP1-6V; No. of samples: n = 5
Carrying current: 0.1 A
Ambient temperature: 25°C 77°F

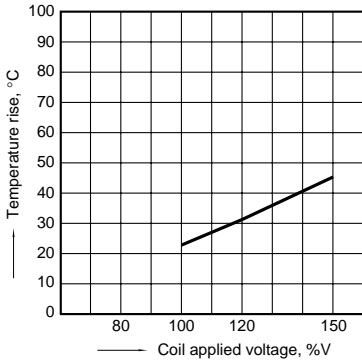

3. Operate/release time

Sample: RP1-9V; No. of samples: n = 50

• With diode

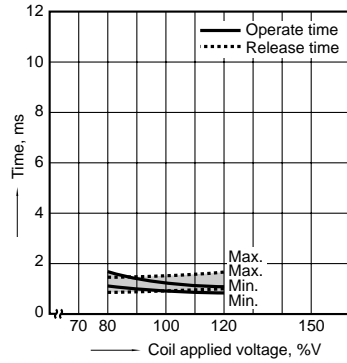

• Without diode

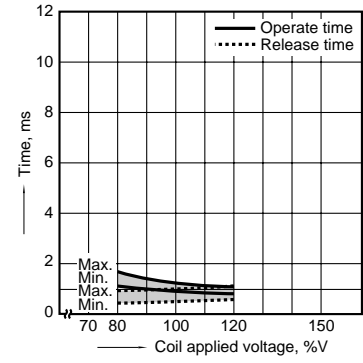

4. Mechanical life

Sample: RP1-5V; No. of samples: n = 8

• Change of pick-up, drop-out voltage

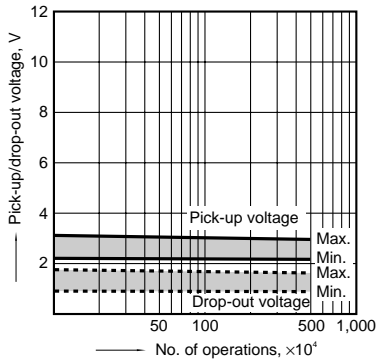

5. Electrical life (0.1 A 30 V DC)

Sample: RP1-6V; No. of samples: n = 6

• Change of pick-up/drop-out voltage

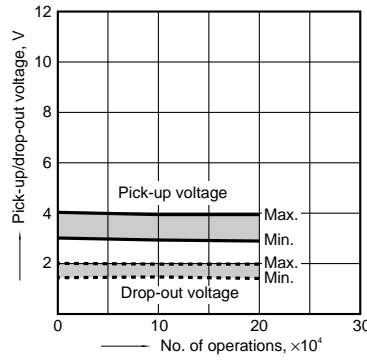

• Change of contact resistance

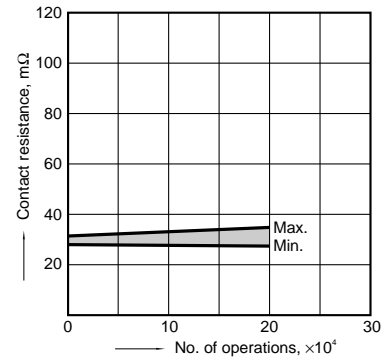

6. Ambient temperature characteristics

Sample: RP1-6V; No. of samples: n = 5

7. Contact resistance distribution (initial)

Sample: RP1-12V; No. of samples: n = 25

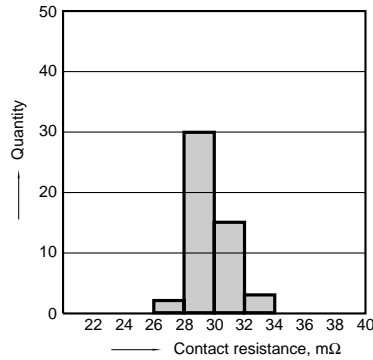
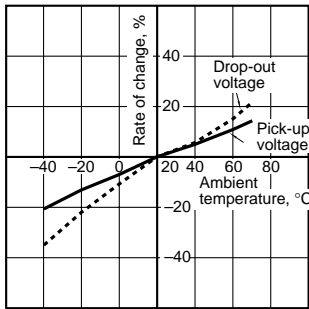

8.-(1) Influence of adjacent mounting

Sample: RP1-12V; No. of samples: n = 6

8.-(2) Influence of adjacent mounting

Sample: RP1-12V; No. of samples: n = 6

8.-(3) Influence of adjacent mounting

Sample: RP1-12V; No. of samples: n = 6

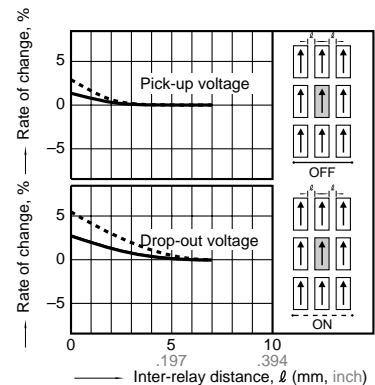
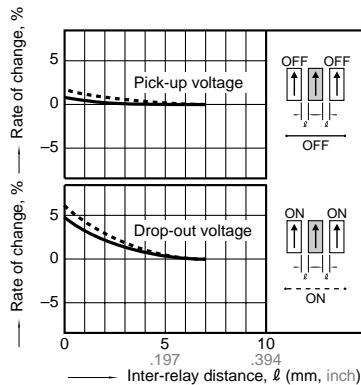
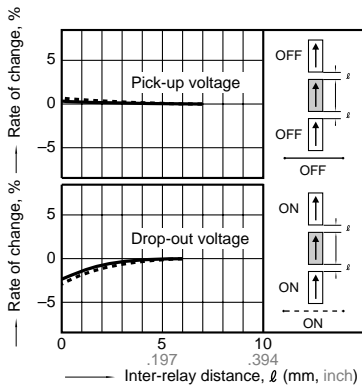



Discontinued
Last time buy: August 31, 2012

RP

9. High frequency switching test (1.2 GHz, 1 W)

Sample: RP1-6V; No. of samples: n = 6

Ambient temperature: 20°C 68°F

• Change of pick-up/drop-out voltage

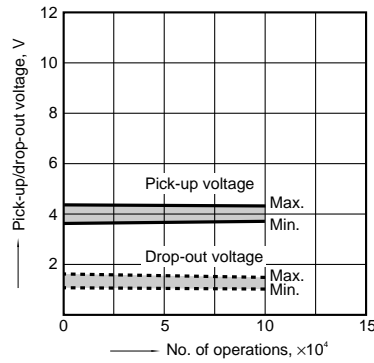
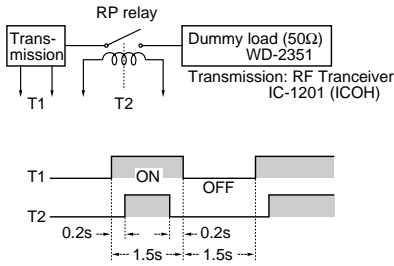

• Change of contact resistance

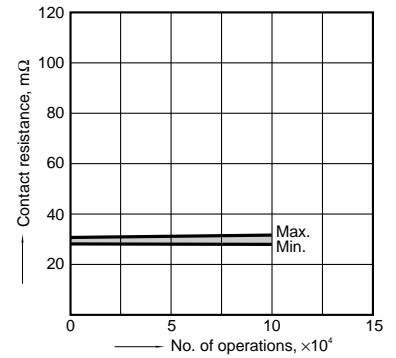

DIMENSIONS (mm inch)

The CAD data of the products with a **CAD Data** mark can be downloaded from: <http://industrial.panasonic.com/ac/e>

CAD Data



Standard PC board terminal

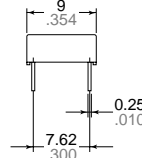
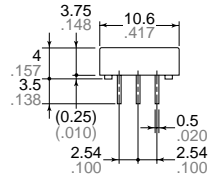

PC board pattern (Bottom view)

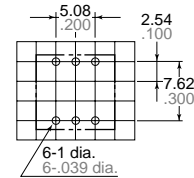

Tolerance: $\pm 0.1 \pm 0.004$

Self-clinching terminal

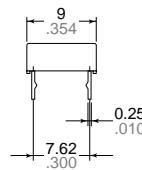
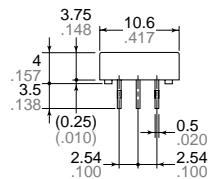

General tolerance: $\pm 0.3 \pm 0.012$

Schematic (Bottom view)

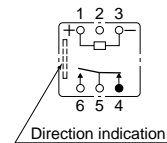

Deenergized condition



NOTES

1. Coil operating power

Pure DC current should be applied to the coil. The wave form should be rectangular. If it includes ripple, the ripple factor should be less than 5%. However, check it with the actual circuit since the characteristics may be slightly different. The nominal operating voltage should be applied to the coil for more than 20 ms to set/reset the latching type relay.

2. Coil connection

When connecting coils, refer to the wiring diagram to prevent mis-operation or malfunction.

3. External magnetic field

Since RP relays are highly sensitive polarized relays, their characteristics will be affected by a strong external magnetic field. Avoid using the relay under that condition.

4. Packing direction

Relays are packed in a tube with the orientation stripe (PIN NO. 1) toward the green stopper.

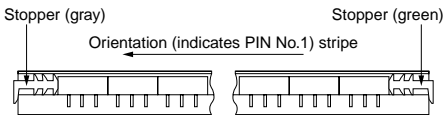

5. Automatic mounting

To maintain the internal function of the relay, the chucking pressure should not exceed the values below.

Chucking pressure* in the direction A:

4.9 N {500 gf} or less

Chucking pressure* in the direction B:

9.8 N {1 kgf} or less

Chucking pressure* in the direction C:

9.8 N {1 kgf} or less

Please chuck the portion.

Avoid chucking the center of the relay. In addition, excessive chucking pressure to the pinpoint of the relay should be avoided.

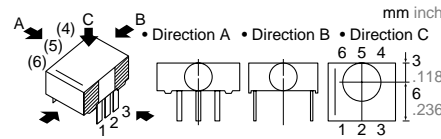

*Value of chucking pressure is shown by the value of weight pressed on the portion (4 mm .157 inch dia.).

6. Soldering

Preheat according to the following conditions.

Temperature	120°C 248°F or less
Time	Within 2 minute

Soldering should be done at 260±5°C 500±9°F within 6 s.

For general cautions for use, please refer to the "General Application Guidelines".